

Planta Baixa Drenagem
ESC. 1:200

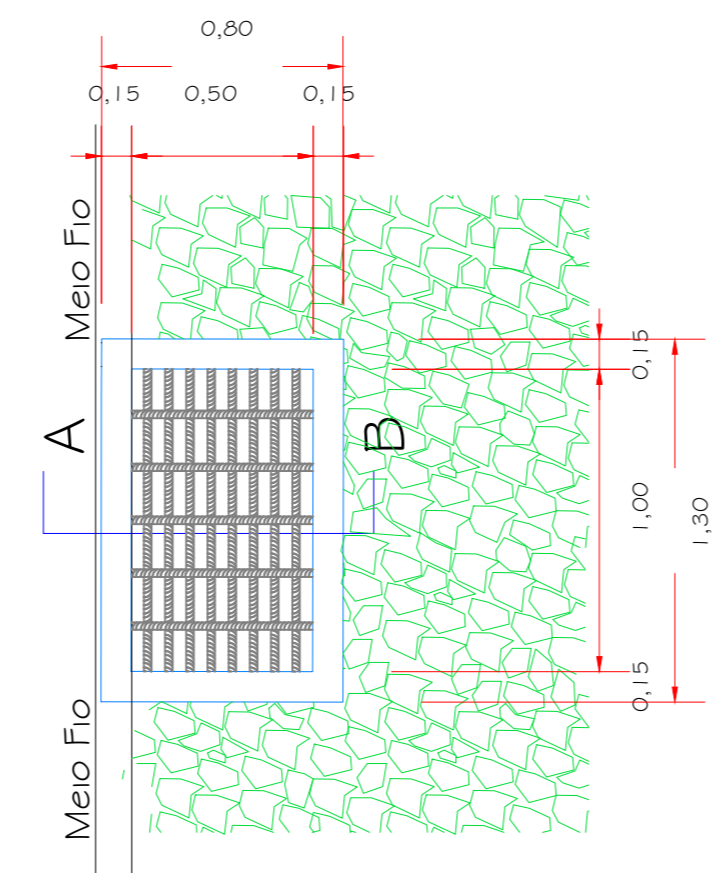

PLANTA
BL/01-130x80/120
ESC. 1:25

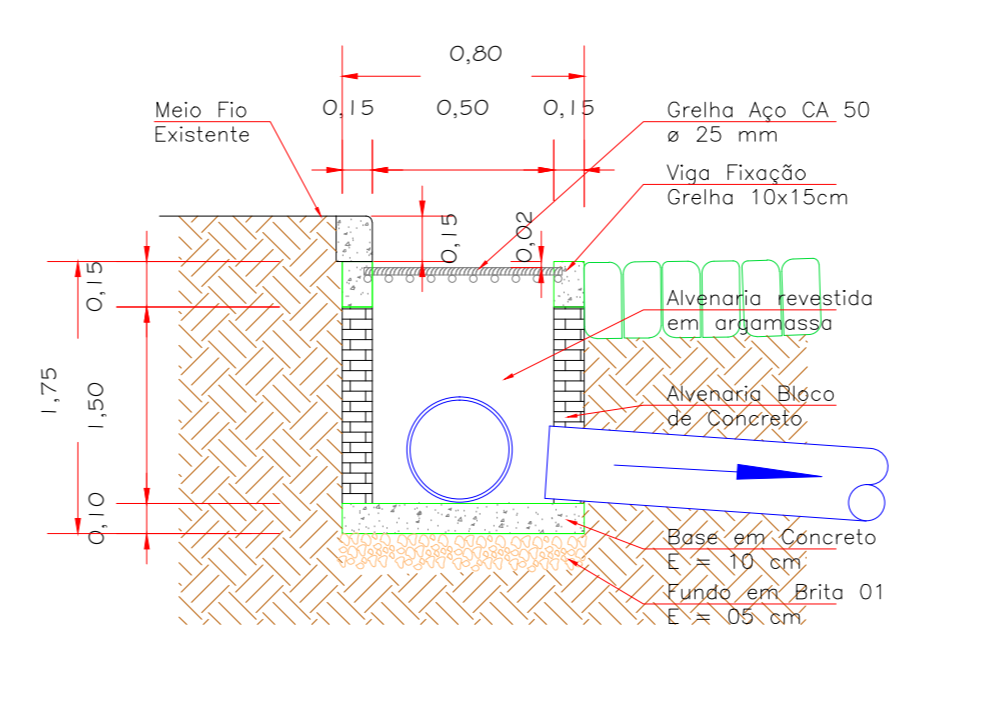

CORTE
BL/01-130x80/120
ESC. 1:25

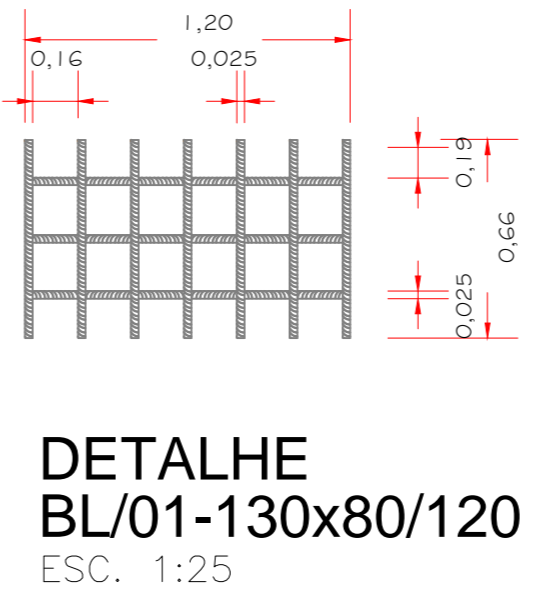

DETALHE
BL/01-130x80/120
ESC. 1:25

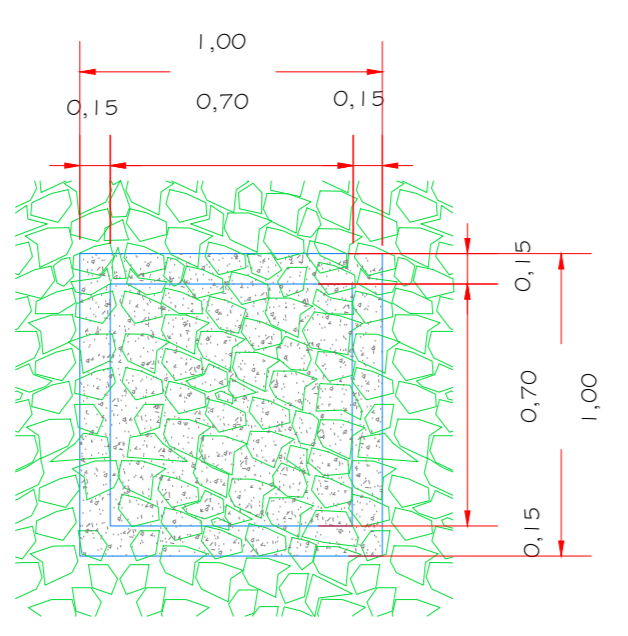

PLANTA
CP01-100x100/80
ESC. 1:25

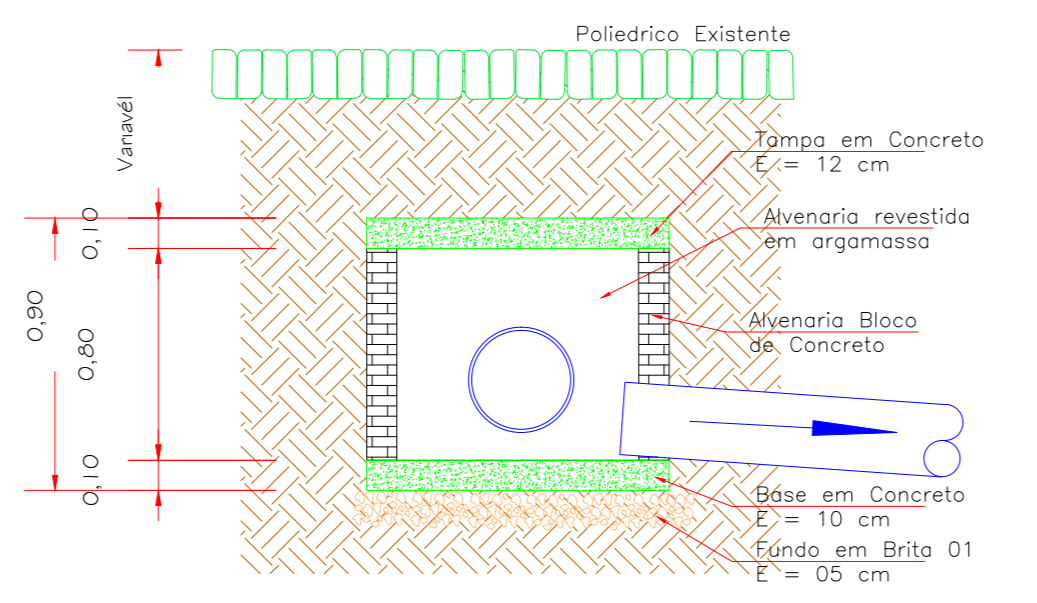

CORTE
CP01-100x100/80
ESC. 1:25

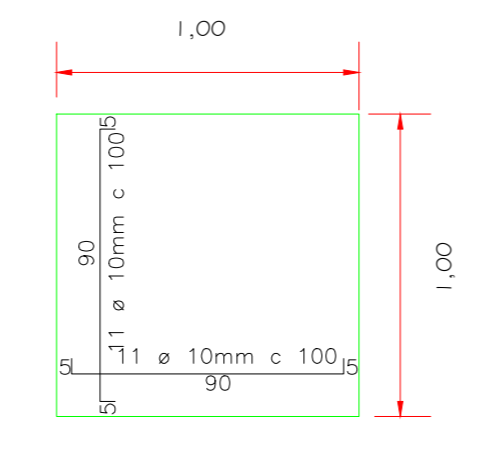

DETALHE
CP01-100x100/80
ESC. 1:25

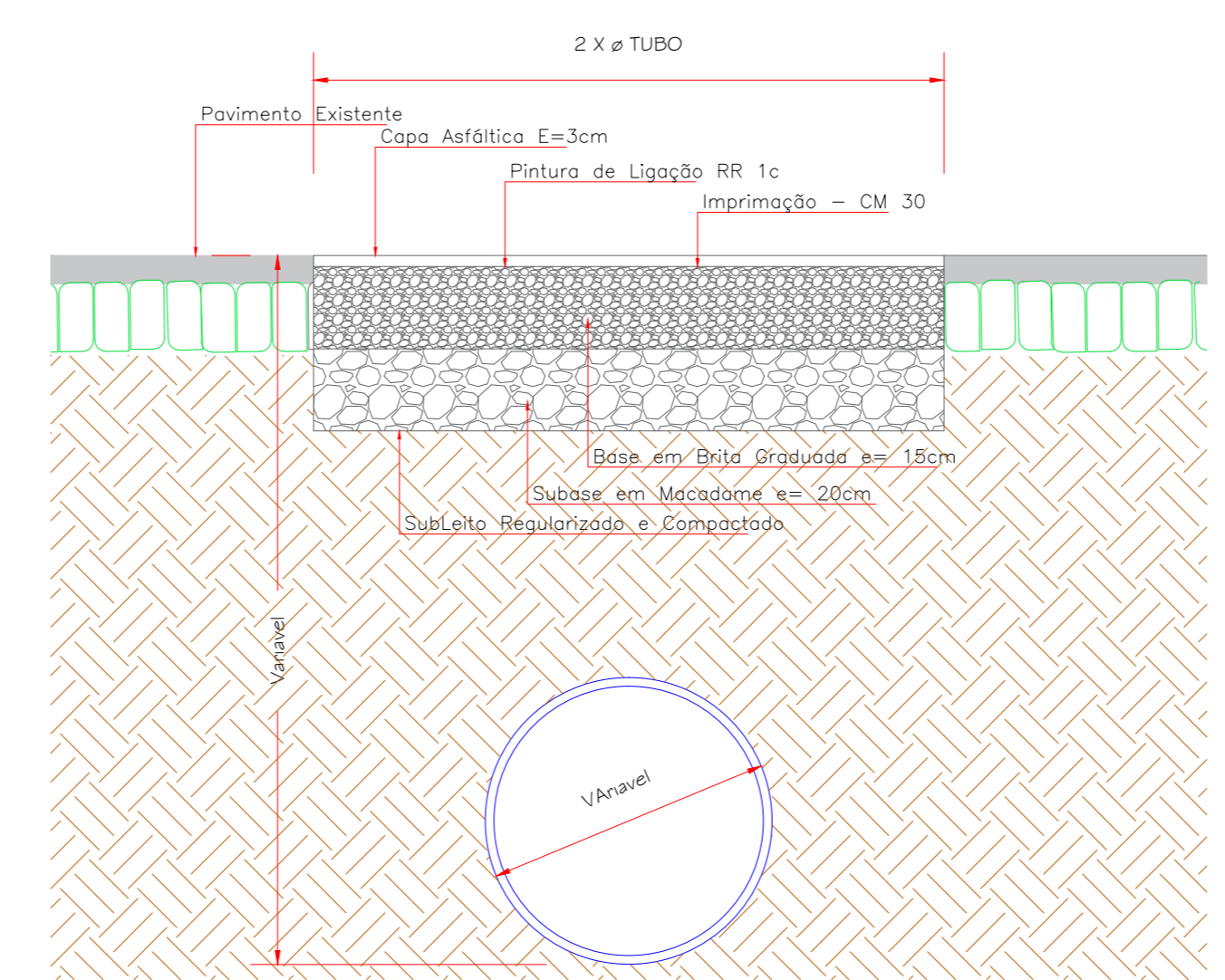

DETALHE
ESC. 1:25

PREFEITURA MUNICIPAL			
Administração 2017 / 2020			
ADMINISTRAÇÃO	PROJ. TÉCNICO	PLANO	01/04
		PROJETO	DRENAGEM
OBJETO	REFORMA E REVITALIZAÇÃO DE VIAS URBANAS	ÁREA	2.016,48 m ²
		DATA	MARÇO / 2019
OPERAÇÃO	INFRAESTRUTURA - RECAPEAMENTO ASFÁLTICO	LOCAL	
ENDEREÇO	AV. PRESID. KENNEDY ESQ. C/ RUA FIRMO HABLICH	SITUAÇÃO	INDICADA
BAIRRO	DOIS VIZINHOS - PARANÁ		